

**ROAD MAINTENANCE MANAGEMENT SYSTEMS – IMPLEMENTATION OF
THE ROAD MENTOR 4 SYSTEM IN THE CENTRAL ZONE**

by

Eng.T Mosso*, Eng. D .Weston**, Eng. J Katala***,Eng. J Mallya**** and Eng. N
Mwangosi****

*Central Zone Director, TANROADS, Arusha, Tanzania

**Senior Highway Engineer, TRL Limited, UK

*** Project Coordinator, TANROADS, Dar es Salaam, Tanzania

**** Project Engineers, TANROADS, Central Zone-Arusha, Tanzania

ABSTRACT

Following the re-organisation of the roads sector and the formation of TANROADS and the Road Funds Board in 2000, there has been a greater need for a Road Management System to cover the whole of the national trunk and regional roads network. Performance targets are a feature of the new road maintenance arrangements. Since the beginning of 2001 TANROADS has been working with TRL Limited of the UK under a project managed by TANROADS and jointly funded by DFID and the Roads Fund Board, to provide an improved version of a project level system, Road Mentor 3. The improved system, Road Mentor 4, as well as being more suited to network use, has been rewritten in Visual Basic and uses Microsoft Access tables to store data, both in order to be compatible with current operating systems. It can be run on PCs equipped with either Windows 98 or 2000. The main modules of the new Road Mentor 4 programme were completed early in 2002.

It was realised that considerable effort would be needed to populate the system with reliable and compatible data. Consequently a 2nd phase of the project is being carried out in which, with TRL assistance, the Road Mentor System would be implemented just within a single Zone. Experience gained in this exercise would be used to plan the subsequent implementation across the rest of Tanzania.

This paper describes the progress made up to the end of September 2002 in implementing The Road Mentor system within the Central Zone and describes the general features of the system.

1 INTRODUCTION

1.1 General

Following the re-organisation of the Tanzanian roads sector and the formation of TANROADS and the Road Funds Board in 2000, there has been a greater need for a Road Management System to cover the whole of the national trunk and regional roads network. The main objectives of establishing the computerised Road Maintenance Management System (RMMS) are to optimise the use of limited resources available for maintenance works; to have a systematic approach and planning of road maintenance works programmes and to reduce the entire transport costs through proper and timely maintenance works.

Since the beginning of 2001 TANROADS has been working with TRL Limited of the UK under a project managed by TANROADS and jointly funded by DFID and the Roads Fund Board, to provide an improved version of a project level system, Road Mentor 3 (Katala and Toole, 2000). The improved system, Road Mentor 4, as well as being more suited to network use, has been rewritten in Visual Basic and uses Microsoft Access tables to store data, both in order to be compatible with current operating systems. It can be run on PCs equipped with either Windows 98 or 2000.

The main modules of the new Road Mentor 4 programme were completed early in 2002. At this time it had become evident during condition surveys carried out in 2001 that there would be considerable effort needed to populate the system with reliable and compatible data. Also, it was realised that the final features of Road Mentor could only be determined after some use of the system. Consequently a 2nd phase of the project was carried out in which, with TRL assistance, the Road Mentor System would be implemented just within a single Zone. Experience gained in this exercise would be used to plan the subsequent implementation across the rest of the country.

This paper describes the progress made up to the end of October 2002 in implementing Road Mentor within Central Zone and describes the general features of the system.

The Road Mentor 4 system includes data on road ordnance, road inventory, pavement condition, traffic and works history. It also includes a module which will identify homogeneous road sections and create a file of details for use with HDM-4 which will be used as the principal tool for strategic, programme and project analysis of maintenance.

2 DESCRIPTION OF ROAD MENTOR 4

2.1 General

The Road Mentor system is based on a series of tables contained in an Access database. Data in these tables is viewed, input and edited via a programme written in Visual Basic. Whilst data held within the system can be viewed through various screens it is expected that the main means of viewing system data will be through a series of standard reports created using Crystal Reports software.

The entire TANROADS network has been divided into Links which is defined as a length of road between two defined points in the road network, termed nodes. Nodes are defined as points on the ground that identifies permanent physical features of the road network. Typically, nodes are placed at the start and end of roads; intersections where two or more roads meet; regional and district capitals; major towns and at administrative boundaries. Each link is divided into a number of sub-links each 1 km in length together with an end sub-link which is usually a partial kilometre.

Road Mentor 4 is intended to be used as a network information system that will be used to assemble, organise and store data about road network. Most of the data tables are split into

records for a 1 kilometre length of road. The typical, average or dominant values of a particularly feature such as pavement type, road width or overall condition are contained in each record. The distances of culverts, bridge centres and junctions from the start of a sub-link, measured to the nearest 1 metre are recorded.

2.2 Input Screens

The User is presented with a number of screens at several levels. The first screen seen on entry to the system is the Highway Ordnance screen at Level 1, see Figure 1. From here the User can obtain access to Level 2 screens from a series of buttons on the Highway Ordnance screen. A further level of screens is available from the Inventory level 2 screen. The overall structure of the screens is shown in Figure 2.

Figure 1: Main Ordnance Screen

2.3 System Security

The Road Mentor system allows for three types of users and aim to maintain the integrity of the data while allowing access to users as required. The types of user are:

User: who will need to access the data but not make any changes to the data;

Data Technician: who will update the data from surveys;

Supervisor: who will be able to update the master Highway Ordnance table and will also control the Usernames and passwords used to allow access to relevant areas of the system.

All types of user will be able to run reports of any of the data

2.4 Highway Ordnance

The Highway Ordnance table in the Road Mentor system holds the key reference to all roads and links in the system. In normal usage only the System Manager can edit existing data and add new data to this screen. During the substantial editing that has been necessary during the initial piloting of the system this has been relaxed to allow Data Technicians also to edit.

There are built-in checks to ensure that both Node and Link numbers are not repeated. (A fundamental principle of the Tanzanian ordnance is that these items are uniquely numbered.)

Figure 2: Structure of the Road Mentor Screens

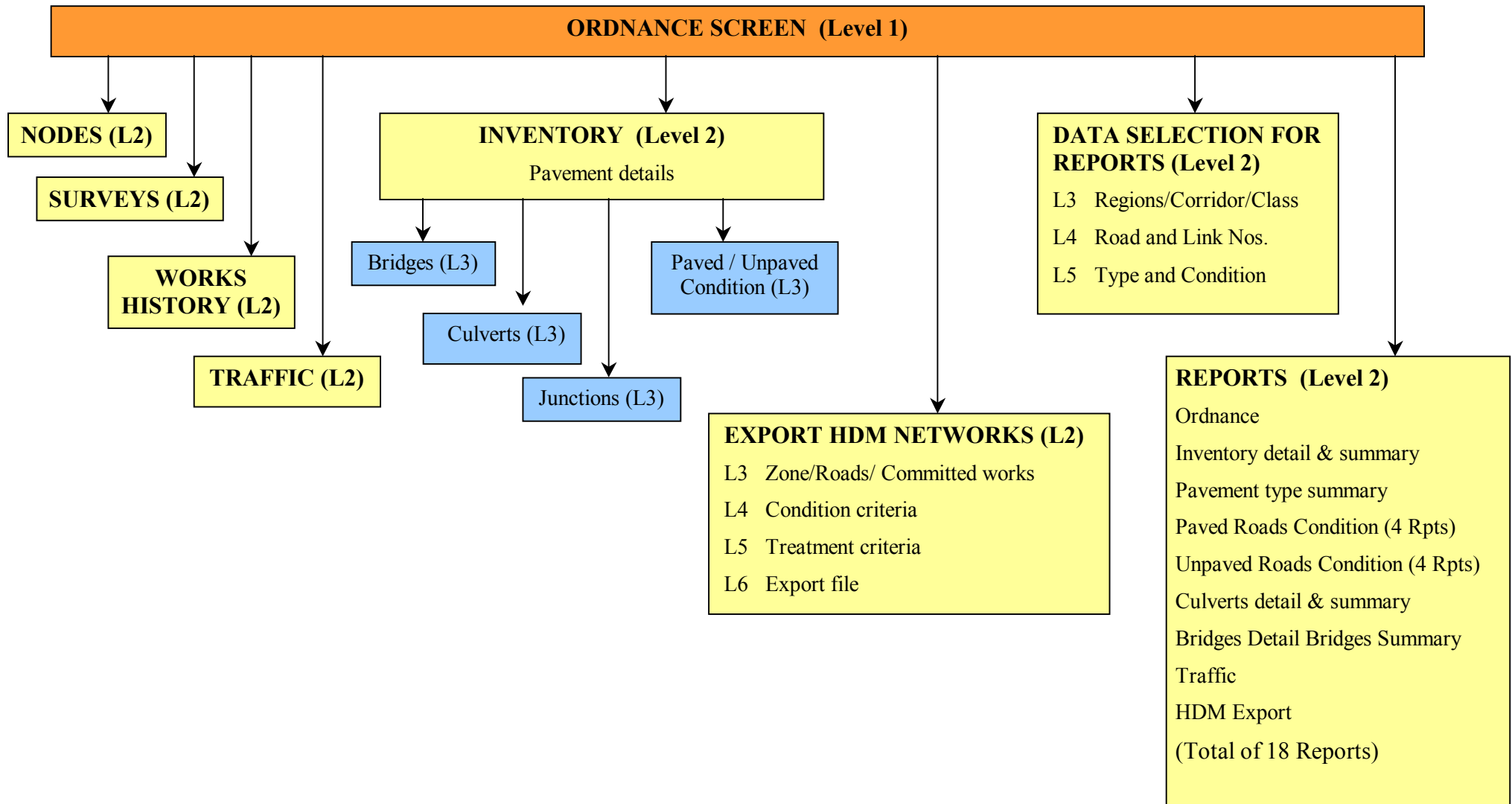

A grid on the left-hand side of the screen shows a list of all links and related road numbers in the Highway Ordnance database table and is the master reference for all data held in the system. Data for specific links can be viewed by selecting the relevant link.

The Ordnance screen displays the following data for a selected link:

Road number, Link number, Region, Corridor,

Start and End Nodes: Number, name and longitude and latitude

Road length, Traffic details, Climate and Altitude.

The longitude and latitude of the nodes has been introduced as a measure to improve the recognition of nodes, which are generally unmarked, and in some instances can be difficult to identify. TANROADS has acquired several hand-held Garmin 12XL Global Positioning System (GPS) units, which are used by the survey teams to verify their locations at doubtful locations. This is not the primary means of locating nodes but can be very useful in cases of uncertainty. Node description notes which have been prepared by Regional Manager's offices are primarily used to identify nodes.

2.5 Inventory

The general features for this screen are shown in Figure 3. This displays some of the Ordnance information to confirm the location of the selection, together with information on the more or less permanent features of the road such as:

types of surfacing and base, road width, shoulder type and width, gradient, curvature, single or dual, number of lanes, cross-section, guard rails and signs, drainage, railway crossings, and adjacent land use.

The precise location and other details of Bridges, Culverts and junctions are entered through level 3 screens accessed via the buttons on the Inventory screen.

Figure 3: Inventory Screen

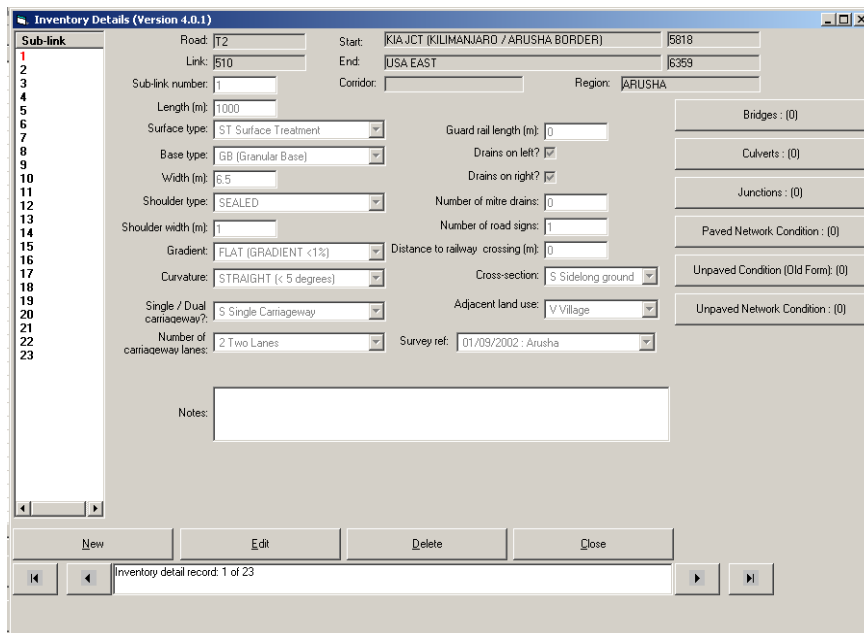

2.6 Condition Data

The screens for entry and viewing of condition survey data are accessed via the Inventory screen.

Paved road condition data consists of roughness, measured using the Road Measurement Data Acquisition System (ROMDAS) mounted in a special vehicle fitted with a bump integrator, and the 20 key rating keyboard for other visually assessed defects. The schematic presentation of the ROMDAS system is summarised in figure 4.

The Paved Network Condition screen in Road Mentor will allow input of the following condition data for each sub-link (1km): Surface type, shoulder type, surface Loss, overall condition, rutting, potholes, patching, wide cracks, ravelling, bleeding, stripping, shoulder condition, drainage condition, roughness and the need for urgent works.

The condition parameters are expressed in numerical values usually on a scale of 1 to 5, defined in the Road Mentor Data Collection Manual (TANROADS, 2002).

Unpaved road condition data for unpaved roads are collected by visual assessment during a drive over survey recording the following data for each sub-link: Surface type, spot improvement needed, overall condition, drainage condition, side slopes condition, shoulder condition, carriageway shape, carriageway surface condition, need for urgent works, condition of culverts, need for culvert repairs, need for new bridges, need for bridge repair and need for river protection.

Again, the condition parameters are expressed in numerical values usually on a scale of 1 to 5, defined in the Road Mentor Data Collection Manual.

Figure 4: The ROMDAS system

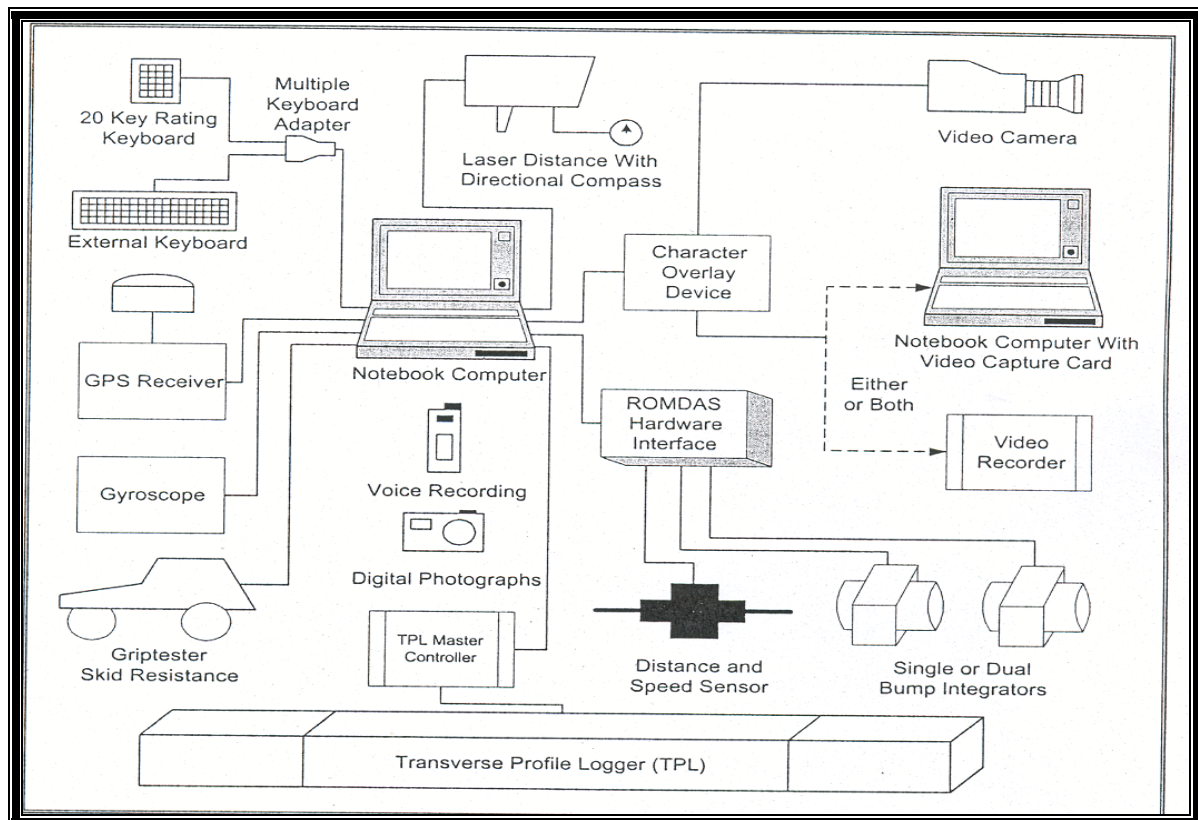

2.7 Export of HDM-4 network file

The HDM-4 investment analysis model is used to investigate network level strategies and programmes and project level analyses. The HDM-4 model requires information on the network, which will be imported from the Road Mentor asset management system. HDM-4 export file module in the Road Mentor 4 is used to create homogeneous sections automatically by using a series of rules and thereby creating an HDM-4 export file. The export file created is compatible with the HDM-4 input requirements. The user will be able to specify the roads to be included in the following manner:

- Road type (paved , unpaved or both)
- Road class (trunk, regional or both)
- Zone (one or all)
- Specific road (one road or all)
- Committed works (to be identified as specific sections or not) .

The user will also have control over the Condition Sectioning criteria, which are:

- Traffic range
- Roughness range (IRI m/km)
- Cracking parameter
- Pavement age
- Structural Number - considered, Yes or No
- Carriageway width - considered, Yes or No
- Traffic flow - considered, Yes or No

The final stage of selection allows the user to combine sections with the same treatments. The number of sections resulting from the current criteria can be displayed and the criteria adjusted to produce more or fewer sections as required.

Finally the details of the accepted homogeneous section is exported to an HDM4 compatible file containing all the section details required for full HDM-4 analysis. Project, programme and strategic analyses would be carried out in HDM-4 and results used in decision making process on various roads investments options and strategies.

Figure 5 illustrate the link between Road Mentor system and HDM-4 model

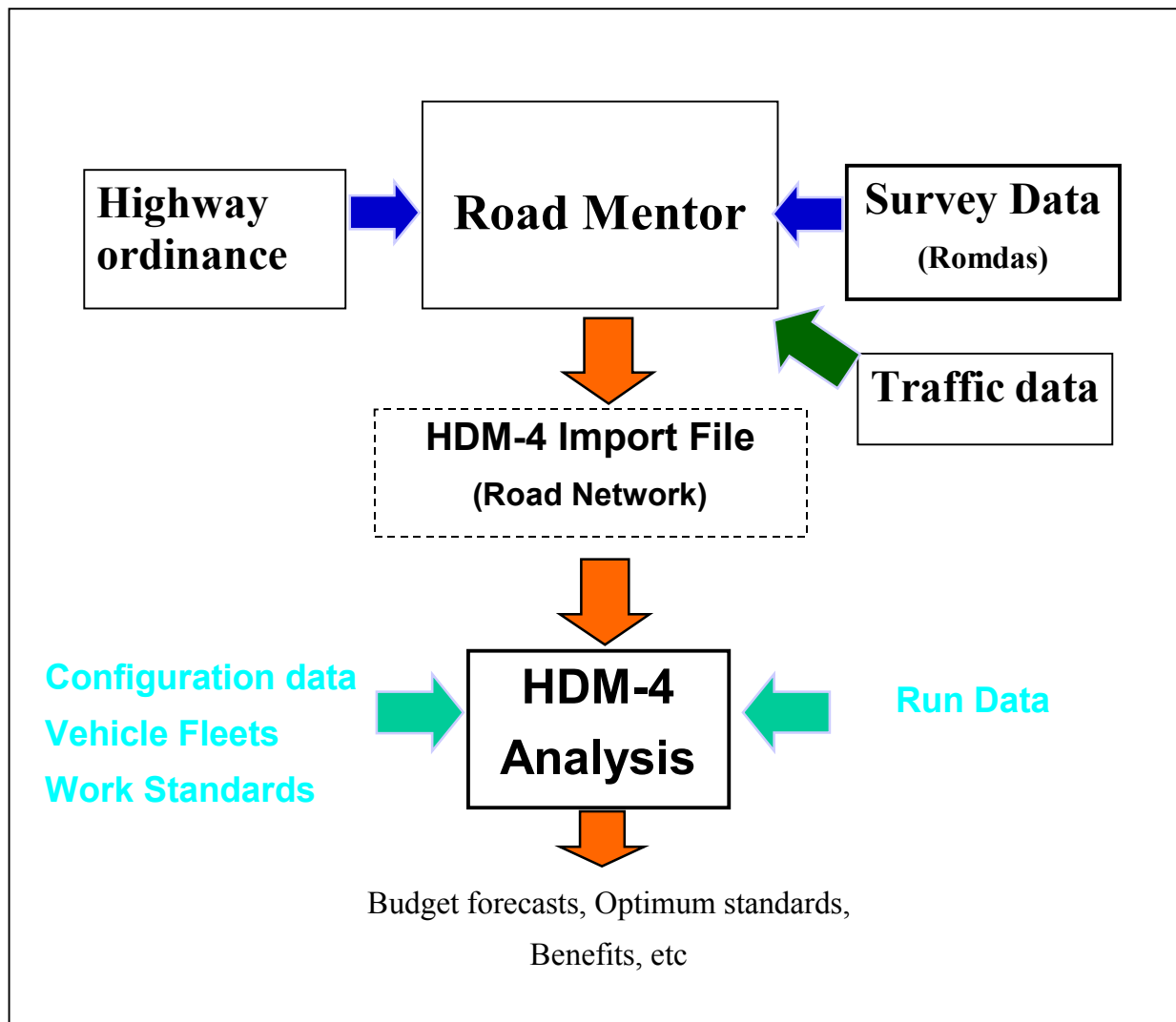
Figure 5: The Road Mentor and HDM-4 configuration.

2.8 Reports

Individual records can be viewed through the different screens, already described. However to get a more general impression of the various types of data it is expected that standard report such as a link in the Highway Ordinance or a sub-link record in the Inventory. A report can be generated for any length of road from as little as a part of a single link to the whole of Tanzania. A wide range of selection criteria has been built into the selection process that is carried out on three tab screens (see Figure 1). The user can select the roads to be reported, on the basis of

- Location (Regions, Zones whole of Tanzania),
- Road classes (Trunk or Regional),
- Road numbers, Link numbers,
- Pavement type

- Pavement condition (roughness or overall condition).

In general, two basic types of reports can be produced – summary and detailed reports. Summary reports are designed to present data for regions, a group of roads or a long road. Detailed reports will provide more data on individual roads or links.

So far 18 standard reports have been created in the system plus two special reports used to assist in the control of data input. The reports are listed in Figure 2. Examples of the following reports described hereunder are given in Appendix A:

Ordinance report

This reports give the detailed information about the road network in a particular region. The information which is available in the ordinance report include; Road Number, link numbers, node names and numbers, link lengths, GPS coordinates and summary of road lengths and total length of road network for a particular region. This report form a basis for road referencing system and it can be used for planning purposes and for network condition surveys.

Inventory Summary report

This reports summarises inventory details information about the road network , it provide pavement lengths, Pavement area, shoulder length, shoulder area, Number of culverts, Number of sublinks with side drains, number of mitre drains, number of bridges, Number of road signs, guards rail lengths, number of junctions, number of railway crossings and number of sub links. All detailed information about these items are available in the inventory detailed report. Inventory information are useful for planning, programming and budgeting purposes. They are the basis and one of the components of RMMS.

Paved roads Roughness report

This report provide information about the condition of the road network in terms of roughness. This report is a result of roughness surveys and it represents roughness in terms of IRI m/km. It displays the roughness for sublinks for a particular region and thereby enabling planners and policy makers to understand the state of the network under their jurisdiction for planning and decision making. The pie chart could also be used to demonstrate the performance of a road network in subsequent years.

Unpaved Roads Condition

This report provide information about the overall condition of the road sub-network. The road sub-network condition is represented by numbers from 1 to 5, meaning very good to very poor respectively. Again, this report provide useful information for planning and programming of maintenance works and it could be used to monitor the performance of the road sub-network in following years

These reports can be previewed from the Road Mentor system and then printed as required. It is also possible to export any of the reports in Excel, Word or PDF format. This will allow for more elaborate analysis, incorporation into other documents or to be transmitted electronically to a user without direct access to Road Mentor.

New reports can easily be added as the system develops.

3 IMPLEMENTATION IN CENTRAL ZONE

During 2001, before Road Mentor 4 was completed, the first condition survey of the paved road network was carried out using the ROMDAS system. Condition surveys were also carried out on the unpaved networks of Kagera and Dodoma regions. All this condition data was input to the Access database tables inherited from the old Road Mentor 3 system and which, in due course, would also be used by Road Mentor 4. The original Inventory surveys had been carried out by several firms of consultants in 1995 and 1996 and input into Road Mentor 3 shortly after.

During the implementation process, It was noticed that there was a compatibility problem between Ordinance, inventory and condition data. Being the case, a series of activities have been carried out to rectify the problem. Proper ordinance and inventory data are pre-requisite and basis for a good Road Maintenance Management System. The activities include:

- Node Location survey
- Verification of Road links and Link lengths
- Inventory surveys

3.1 Node Location survey

It was impractical on the grounds of costs and time to install a system of node markers. TANROADS therefore made the decision to describe in detail all the nodes and sketch plan for complex situations. In addition, a number of Garmin hand-held Global Positioning System (GPS) units were used coordinate all the nodes.

3.2 Verification of Links and link lengths

All road links under TANROADS jurisdiction were verified and uncertainties about ownership between TANROADS and Local Authorities were clarified. The ROMDAS system was used as a digital trip meter to measure distances for all the links.

3.3 Inventory surveys

After Node location survey and verification of link lengths, Inventory surveys were carried out. Brantz precise odometers were used for distance measurements during inventory surveys. It is intended that all future surveys of any kind would be carried out using these devices.

As the ultimate goal is to achieve a near-perfect match of Ordnance and Inventory sub-links (1km) with subsequent condition survey sub-links (1km), all survey lengths need to be measured to an accuracy of better than $\pm 0.5\text{km}$. The Brantz odometers, with proper calibration, can indicate distance within $\pm 0.4\%$. This implies that a link length of 50km is approximately the maximum that can be accepted. On the shorter links, say 10km, this performance is easily achieved.

3.4 Quality assurance

A Data Collection Manual was produced during the first phase of the Road Mentor Project and has since been revised to correct omissions and reflect small changes in the way the data is input to Road Mentor 4. An additional set of procedures has been developed to ensure that data collection and input is carried out correctly and efficiently. This covers such issues as:

- Specifying of Surveys

- Provision of Ordnance reports and Node descriptions to survey teams
- Need to check Link lengths with Ordnance values
- Proper referencing of data forms
- Acceptable tolerances for GPS Nodes longitude and latitude values and Link lengths
- Review of Completed Survey Forms before data input
- Data input to Road Mentor
- Final Review of data input
- Verification of input data with field conditions

3.5 Future Survey Cycle

At the commencement of the 2nd phase of the project, discussions were held at Head Quarters, Zone and Regional levels to establish a tentative annual programme of condition surveys, data input, and preparation of the maintenance programme and release of the revised Road Mentor database to all TANROADS offices. The probable programme is:

- **Ordnance and Inventory Revisions**

As far as possible any adjustments or re-surveys would be carried out and input to Road Mentor before December of each year so as to be available for the condition survey teams.

Adjustments might come from any changes to the network ordnance, inventory and from the records taken from works programmes, but a typical re-survey interval would be set at 5 years interval

- **Paved Roads Condition Surveys**

These surveys would be carried out by HQ staff using the ROMDAS system in the period of December to February each year and would require minimal input from Regional staff. For resource reasons possibly not all would be included. If this was the case the choice of which roads were to be surveyed would be discussed with the Regional Managers.

All data input would be by HQ staff and would be completed by the end of February each year.

- **Unpaved Roads Condition Surveys:**

These would be carried out by the Regional staff under the direction of the Zone Office, in December to February and would use precise odometers and GPS units to ensure a good match of survey data with the Ordnance and Inventory.

All data input would be done at the Zone Office and also to be completed by the end of February and would probably involve data technicians seconded from one of the Regional Offices.

- **Preparation of Maintenance Programmes**

This would normally be carried out at HQ in the period March to April by using HDM-4 model.

- **Release of Revised Database**

At the end of April of each year a new national version of the Road Mentor Database will be released for all users. This will contain all the recently collected condition data and any

Ordnance and Inventory revisions. HQ users will be able to obtain new versions via the TANROADS HQ network but in the short term CDs will have to be issued to Zonal and Regional users.

4 CONCLUSIONS AND RECOMMENDATIONS

- i. The ordnance and inventory data for 7000km of paved and unpaved roads in the Central Zone is complete and in place after verification of ordnance and new inventory surveys. The nodes have been fully described and links verified. Consequently, the Road Mentor system database now represents the accurate road network data in the zone. On future implementation in the other Zones, a procedure will be recommended that will firstly check and adjust the road ordnance prior to proceeding with any inventory or condition surveys.
- ii. The absence of node and distance markers on road network makes surveys difficult to manage. However, the routine use of precise odometers and GPS units has been found to overcome this problem. In future, it is recommended to carry out location reference surveys (LRP) to establish distance markers on road network.
- iii. Road Mentor now contains condition data for:
 - the entire national paved network (3800kms) measured in 2001;
 - the whole of the Central Zone unpaved network (5319 km) measured in 2001 and 2002;
 - the unpaved network of Kagera Region (1434 kms) measured in 2001.
- iv. Road Mentor now has the facility to identify sections of road with uniform condition. This module can be used to create an export file for HDM-4 for maintenance programming. A maintenance programme for the paved road network, based on the condition data available in the Road Mentor database collected in 2001, has now been produced (refer Marmo et al-ARC 2002 paper). In addition, the system has got traffic module whereby all traffic data will be input and assigned to road links accordingly. The module will allow for entry and reporting of both motorised and non-motorised traffic.
- v. The Road mentor system is now fully operational in the Central Zone and preparations are underway to extrapolate the system to other three remaining zones namely Coast, Southern highlands and Lake zones.

5 REFERENCES

1. Katala, J and Toole, T. 2000. Road management systems – The development of the Road Mentor System in Tanzania. Proceedings of Tanzanian Annual Roads Convention 2000.
2. Tanroads, 2002. Data Collection manual, Version 4.2.0.

Appendix A

Examples of Road Mentor Reports

No.1 - Ordnance

No.3 - Inventory Summary

No.8 - Paved roads Roughness (Central Zone)

No.10 - Graph of Unpaved Roads Condition

Road Mentor 4 - Report 1 ORDNANCE

Report Date 29-Sep-02

Created by :

TANROADS

Selection Criteria

Regions: ARUSHA

Corridor: No Corridors Selected

Road Classes: T

Surface Types: No Selection

Roughness: No Selection

Overall Condition: No Selection

Road Numbers: T2,T5

Link Numbers: All Links Selected

Region	Road Class No.	Link	Start Node Number	Start Node Name	End Node Number	End Node Name	Upstream Link	Downstream Link	km Paved	km Unpaved	Start Node Eastings	Start Node Southings	End Node Eastings	End Node Southings
ARUSHA	T 002	510	5818	KJA JCT (KILIMANJARO / ARUSHA BORDER)	6359	USA EAST	505	512	22.45	0.00	36.0627	3.3703	36.8705	3.3686
ARUSHA	T 002	512	6359	USA EAST	6301	USA WEST	510	515	1.39	0.00	36.8705	3.3686	36.8583	3.3713
ARUSHA	T 002	515	6301	USA WEST	6302	PHIUPS	512	520	17.24	0.00	36.8583	3.3713	36.7076	3.3658
ARUSHA	T 002	520	6302	PHIUPS	6303	ARUSHA	515	525	3.05	0.00	36.7076	3.3658	36.6764	3.3630
ARUSHA	T 002	525	6303	ARUSHA	6304	OLDONYO SAMBU	520	530	41.19	0.00	36.6764	3.3630	36.7050	3.0770
ARUSHA	T 002	530	6304	OLDONYO SAMBU	6305	LONGIDO	525	535	38.70	0.00	36.7050	3.0770	36.6979	2.7343
ARUSHA	T 002	535	6305	LONGIDO	6306	NAMANGA (TANZANIA / KENYA BORDER)	530	0	26.20	0.00	36.6979	2.7343	36.7865	2.5477
Total lengths for Road No.							T 002		150.72 km Paved	0.00 km Unpaved	150.72 km Total			
ARUSHA	T 005	1220	2715	BEREKO (DODOMA / ARUSHA BORDER)	6308	BABATI	1215	1224	0.00	34.05	35.7551	4.4203	35.7486	4.2156

Road Mentor 4 - Report 1 ORDNANCE

Page 1 of 2

Report Date 29-Sep-02

TANROADS

Road Mentor 4 : Report 3 - INVENTORY SUMMARY

TANROADS

Report Date 29-Sep-02 Created by:

Selection CriteriaRegions ARLSHACorridor No Corridors SelectedRoad Class T/RSurface Type No SelectionRoughness No SelectionOverall Condition No SelectionRoad Numbers All Roads SelectedLink Numbers All Links Selected

	Paved	Unpaved	All Roads
Pavement length (km)	271.31	937.68	1,208.99
Pavement area (m ²)	1,686,505	4,759,833	6,446,338
Shoulder length (road km)	156.26	N/A	156.26
Shoulder area (m ²)	326,993	N/A	326,993
Number of Culverts	60	271	331
Number of Sub-links with Side Drains	225	647	872
Number of Mitre Drains	114	9,286	9,400
Number of Bridges	9	11	20
Number of Signs	324	107	431
Guard Rail length (m)	13,692	496	14,188
Number of Junctions	1	12	13
Number of Rail Crossings	1	4	5
Number of Sub-links	279	1,230	1,509

Note. All the above summary data are derived from the Inventory survey records.
Missing data will result in under-reporting.

Road Mentor 4: Report 8 - CENTRAL ZONE PAVED ROADS ROUGHNESS SUMMARY

TANROADS

Report Date 29-Sep-02 Created by:

Selection Criteria

Regions ARUSHA,DODOMA,KILIMANJARO,SINGIDA,TANGA

Corridor No Corridors Selected

Road Class T/R Surface Type No Selection

Roughness No Selection Overall Condition No Selection

Road Numbers All Roads Selected

Link Numbers All Links Selected

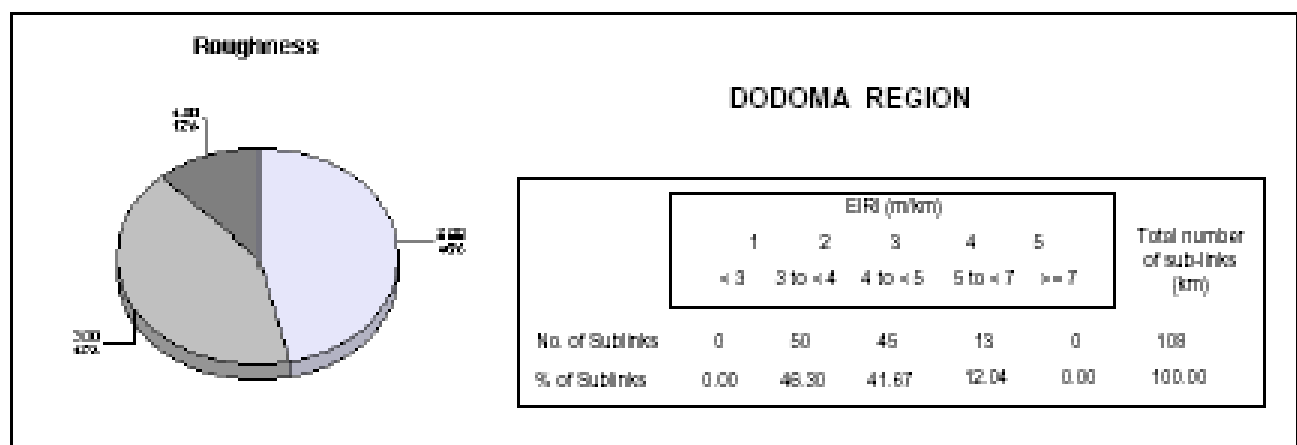
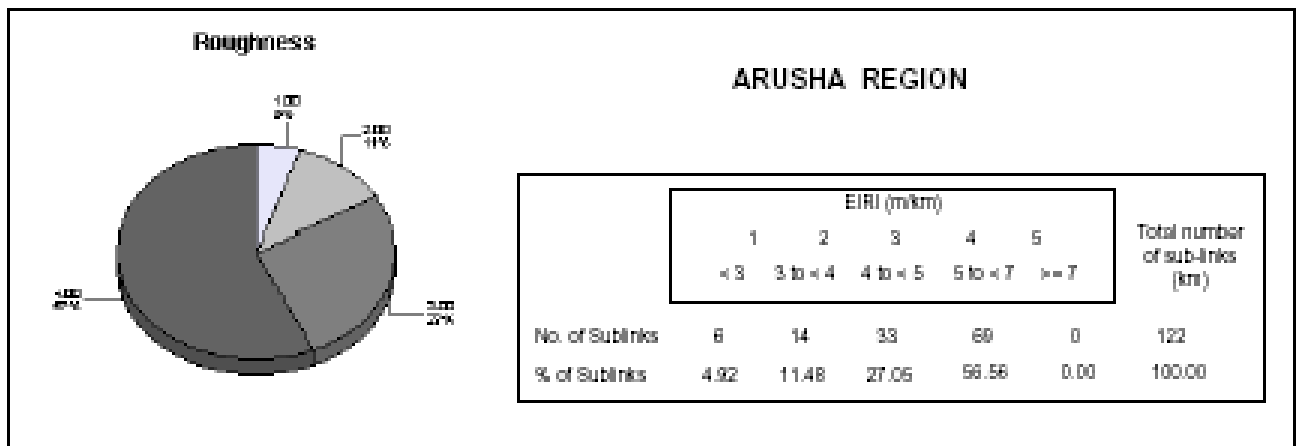

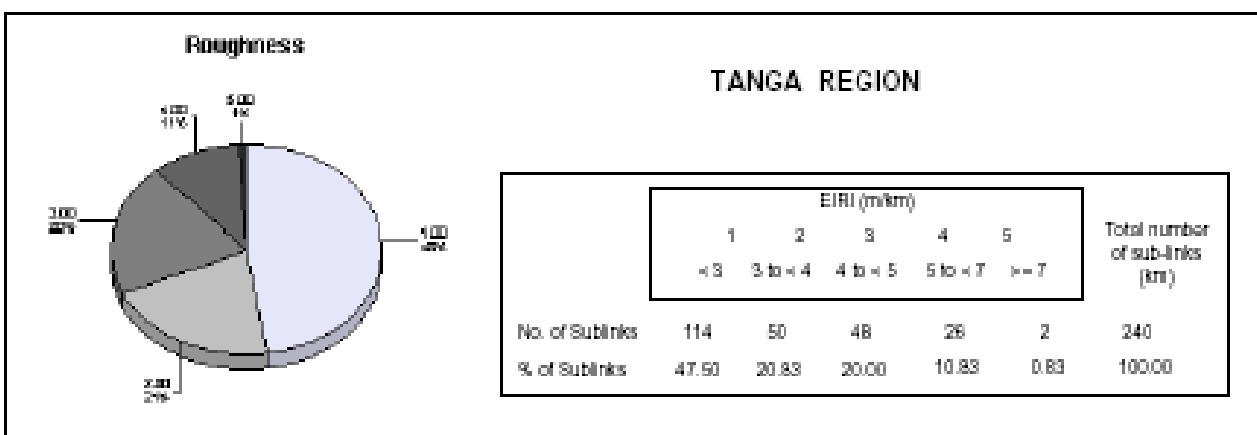
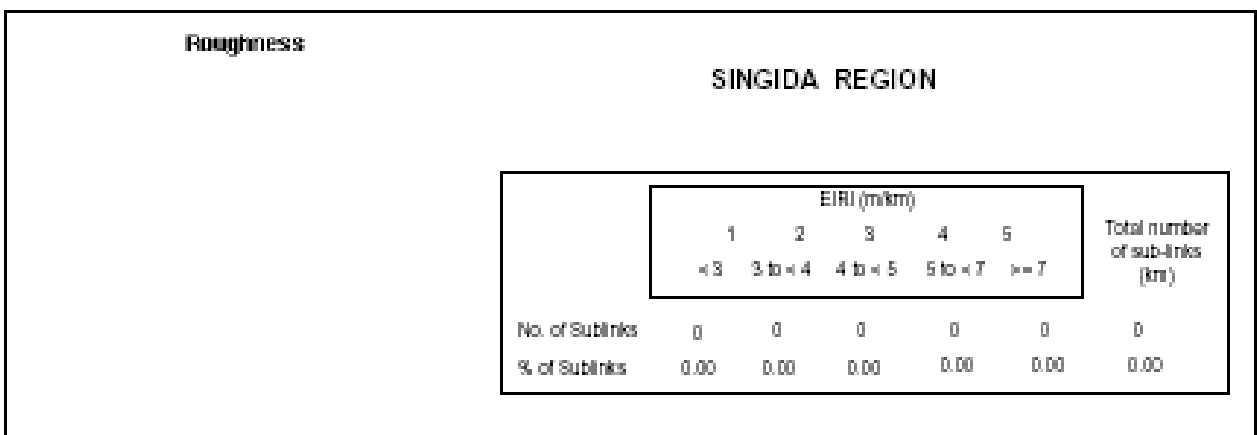
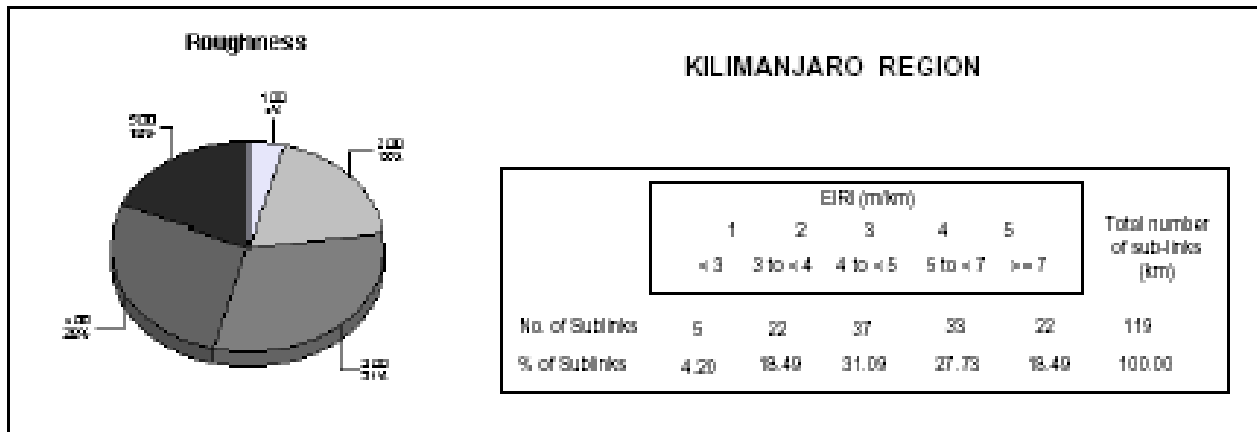

Selection Criteria

Regions: ARUSHA Corridor: No Corridors Selected
Road Classes: R Surface Types: No Selection Roughness: No Selection Overall Condition: No Selection
Road Numbers: R465
Link Numbers: All Links Selected

Overall Condition

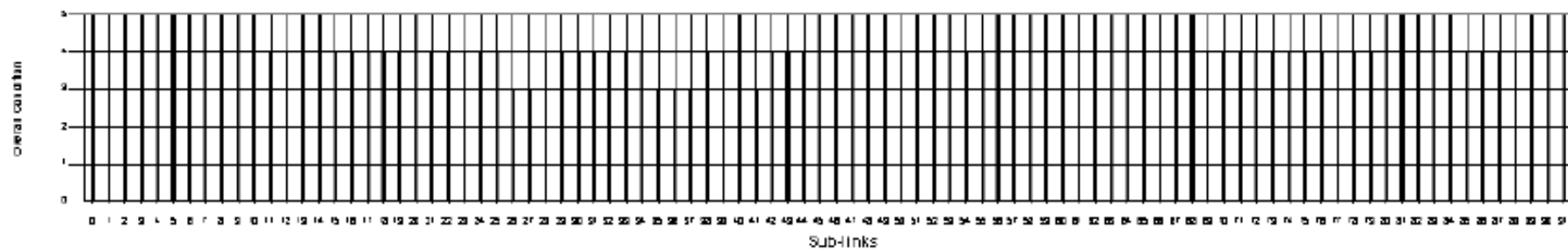

Carriageway Shape

